

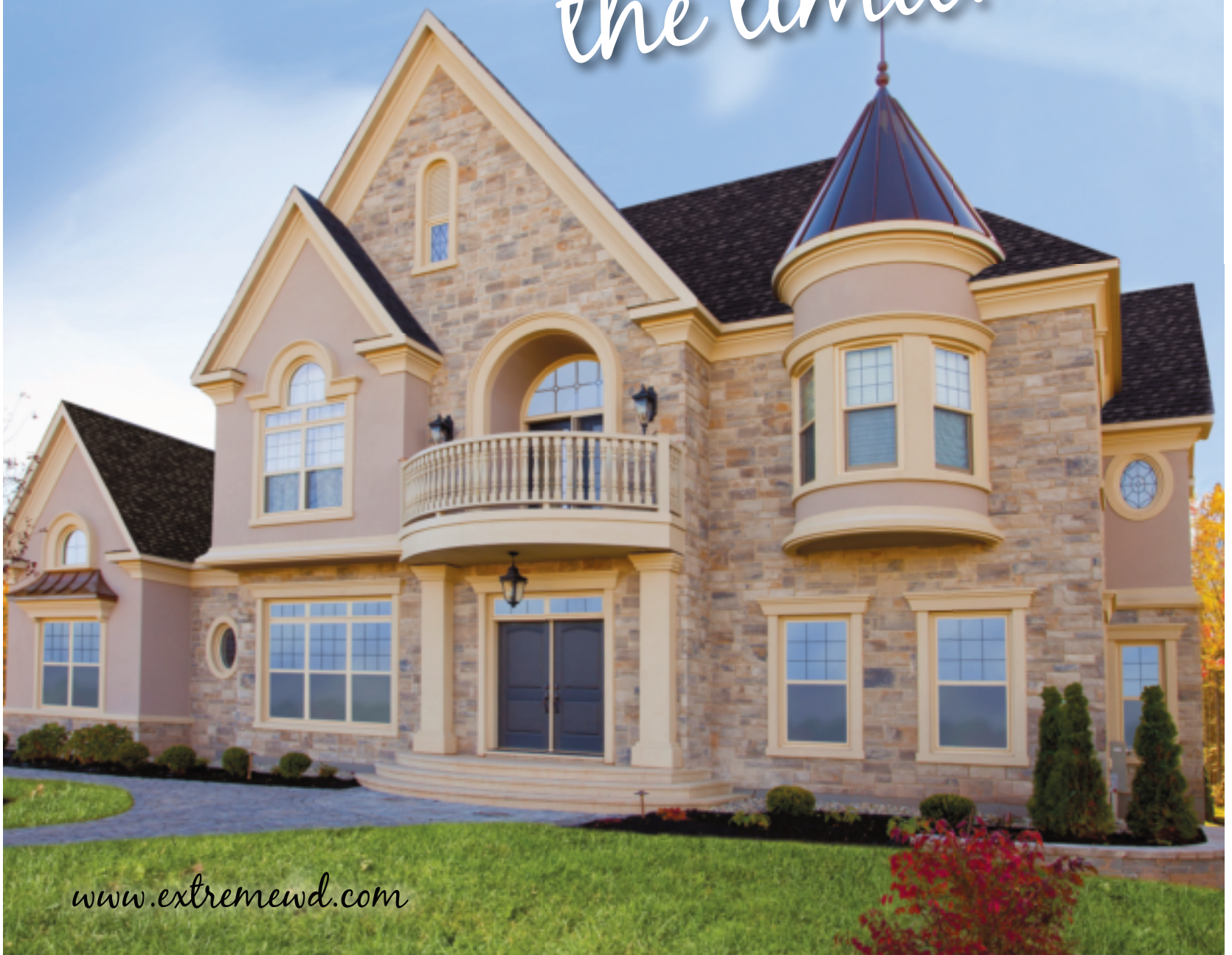

Extreme

WINDOW AND ENTRANCE SYSTEMS

*the sky's
the limit!*



www.extremewd.com

Welcome

- *Commitment*.....4
- *Single Hung Series*.....6
- *Advantage Series*.....10
- *Casement*.....12
- *Awning*.....16
- *Single / Double Slider*.....18
- *Designer Series*20
- *Energy Star*.....22
- *Window Options*.....24
- *Entrance Systems*.....26
- *Integra Patio Door*.....30

Extreme Window & Entrance Systems Inc.
Moncton Industrial Park
Moncton, New Brunswick, Canada
Tel.: 506-384-3667 Fax.: 506-854-5905
www.extremewd.com



Discover the Extreme difference.

Whether you are building or renovating, selecting quality windows and doors for your home is a very important decision. Choosing long-lasting, low-maintenance Extreme windows and doors, is a decision you will be happy with for a lifetime.

With our region's rugged climate and energy-conscious consumers, we specialize in making only high-quality windows and doors for Atlantic Canada and back it up with an industry leading warranty program.

Our Sales, Service, and Technical Support teams combined with our dedicated and loyal production staff are committed to quality service and manufacturing excellence.

Our promise is to use leading technologies to produce top quality products. We partner with the region's best window & door specialists to deliver these top of the line products. Enhancing the comfort, value, and enjoyment of your home.

Quality workmanship goes into every unit we produce.
We guarantee it. For life.



Commitment

At Extreme, we appreciate and understand that in today's marketplace, value, quality, and service are simply expected.

To stand out from our competition we realize that we have to deliver dreams. Our team of professionals are driven by imagination and skill that creates excitement and crafts magic into every product we produce.

Our excellence has made us one of Atlantic Canada's fastest growing companies. Our promises is to produce remarkable performance, versatility, and charm for your homes distinctive style.







Single Hung

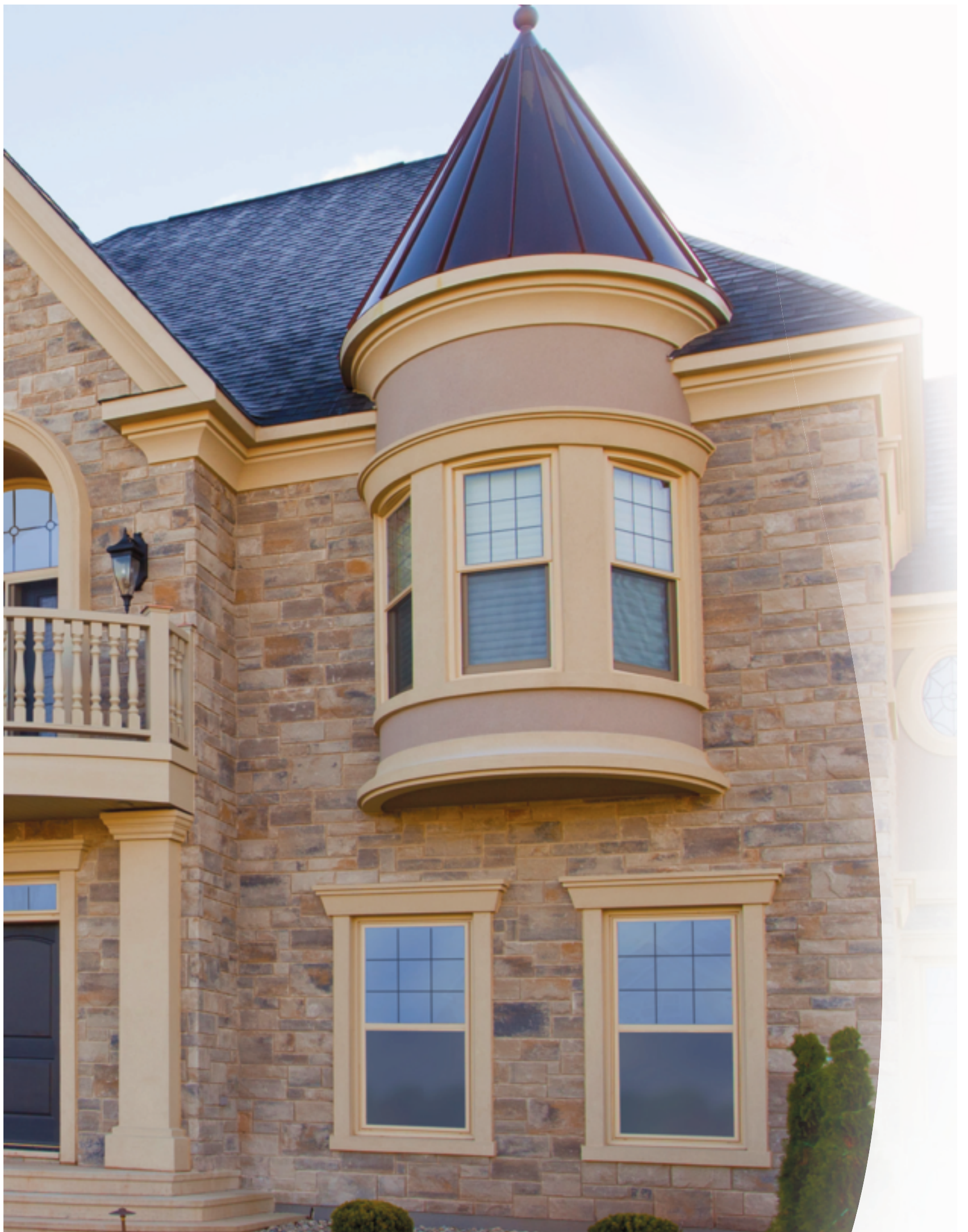

Single Hung

Heritage Series



For the widest selection of styles with the most options in exterior and interior trim, choose the Heritage Series from Extreme. Available in White or Tan extrusion colours, the Heritage Series lets you “dress” your window installation with the appropriate brickmolds and jamb extensions and blend perfectly with any architectural style.

Single Hung 4200

- Top sash is fixed for increased weather tightness
- Bottom sash opens and tilts in for easy cleaning
- Efficient cam locking system for security and a weather-tight seal
- 3 1/4" PVC frame adds strength and durability
- Triple weatherstrip system
- Insert or brickmold options available
- See page 24 for options

Premium Series



For maximum value and energy efficiency, choose the Premium Series. These windows are similar to our Heritage Series with 1 1/2" brickmold and combination drywall/wood return integrated right into the extrusion at the factory. The resulting continuous frame construction is more structurally sound and weather-tight. The brickmold has a nailing fin and can be converted into a siding return.

Single Hung 4256 + 4267

- 4256 Available in 3 1/4" depths
- 4267 Available in 4 1/2" depths
- Top sash is fixed for increased weather tightness
- Bottom sash opens and tilts in for easy cleaning
- Efficient cam locking system for security and a weather-tight seal
- Integrated 1 1/2" brickmold with nailing fin (converts to accept siding)
- Integrated combination 1/2" drywall / 3/4" wood return
- Triple weather-strip system

Save **ENERGY** Save **MONEY**

With our 4 1/2" integrated frame, your window will sit deeper into the wall creating a warmer window.

- ✓ More vinyl giving you a stronger window
- ✓ *Seamless, one piece frame for maximum weather tightness*

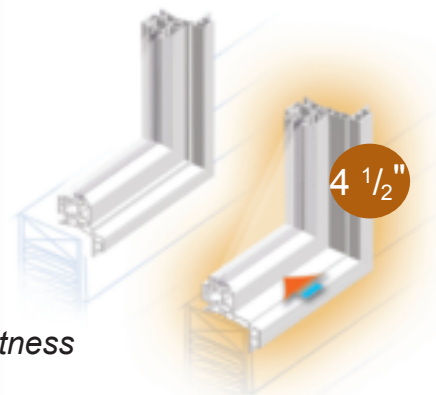

Advantage Series

Built for developers and homeowners across Atlantic Canada. The Advantage Series is setting a new standard in efficiency, superior manufacturing advantage technology, and affordability.

If your looking for the latest innovation in design and construction choose our Advantage Series window.





Single Hung 4245

- Available in 3 1/4" depths
- Top sash is fixed for increased weather tightness
- Bottom sash opens and tilts in for easy cleaning
- Efficient cam locking system for security and a weather-tight seal
- Integrated 1 1/2" brickmold with nailing fin (converts to accept siding)
- Integrated combination 1/2" drywall / 3/4" wood return
- Triple weatherstrip system
- See page 24 for options



Single Hung





Casement





Casement

Heritage Series



For the widest selection of styles with the most options in exterior and interior trim, choose the Heritage Series from Extreme. Available in White or Tan extrusion colors, the Heritage Series lets you “dress” your window installation with the appropriate brickmolds and jamb extensions and blend perfectly with any architectural style.

Casement 4600

- Available in 3 1/4" or 4 1/2" depths
- Concealed, heavy-duty hinges provide a clean look
- Multi-point locking system for optimal security and a weather-tight seal
- Integrated combination 1/2" drywall / 3/4" wood return
- Triple weatherstrip system
- Standard folding crank handle
- Insert or brickmold options available, see page 24

Premium Series



For maximum value and energy efficiency, choose the Premium Series. These windows are similar to our Heritage Series with 1 1/2" brickmold and combination drywall/wood return integrated right into the extrusion at the factory. The resulting continuous frame construction is more structurally sound and weather-tight. The brickmold has a nailing fin and can be converted into a siding return.

Casement 4665

- Available in 3 1/4" or 4 1/2" depths
- Concealed, heavy-duty hinges provide a clean look
- Integrated 1 1/2" brickmold with nailing fin (converts to accept siding)
- Integrated combination 1/2" drywall / 3/4" wood return
- Triple weatherstrip system

Heritage Series



For the widest selection of styles with the most options in exterior and interior trim, choose the Heritage Series from Solarseal. Available in White or Tan extrusion colours, the Heritage Series lets you “dress” your window installation with the appropriate brickmolds and jamb extensions and blend perfectly with any architectural style.

Awning 4600

- Available in 3 1/4" or 4 1/2" depths
- Concealed, heavy-duty hinges provide a clean look
- Integrated combination 1/2" drywall / 3/4" wood return
- Triple weatherstrip system
- Standard folding crank handle
- Insert or brickmold options available
- See all available options on page 24

Premium Series



For maximum value and energy efficiency, choose the Premium Series. These windows are similar to our Heritage Series with 1 1/2" brickmold and combination drywall/wood return integrated right into the extrusion at the factory. The resulting continuous frame construction is more structurally sound and weather-tight. The brickmold has a nailing fin and can be converted into a siding return.

Awning 4665

- Available in 3 1/4" or 4 1/2" depths
- Concealed, heavy-duty hinges provide a clean look
- Integrated 1 1/2" brickmold with nailing fin (converts to accept siding)
- Integrated combination 1/2" drywall / 3/4" wood return
- Triple weatherstrip system
- Optional folding crank handle

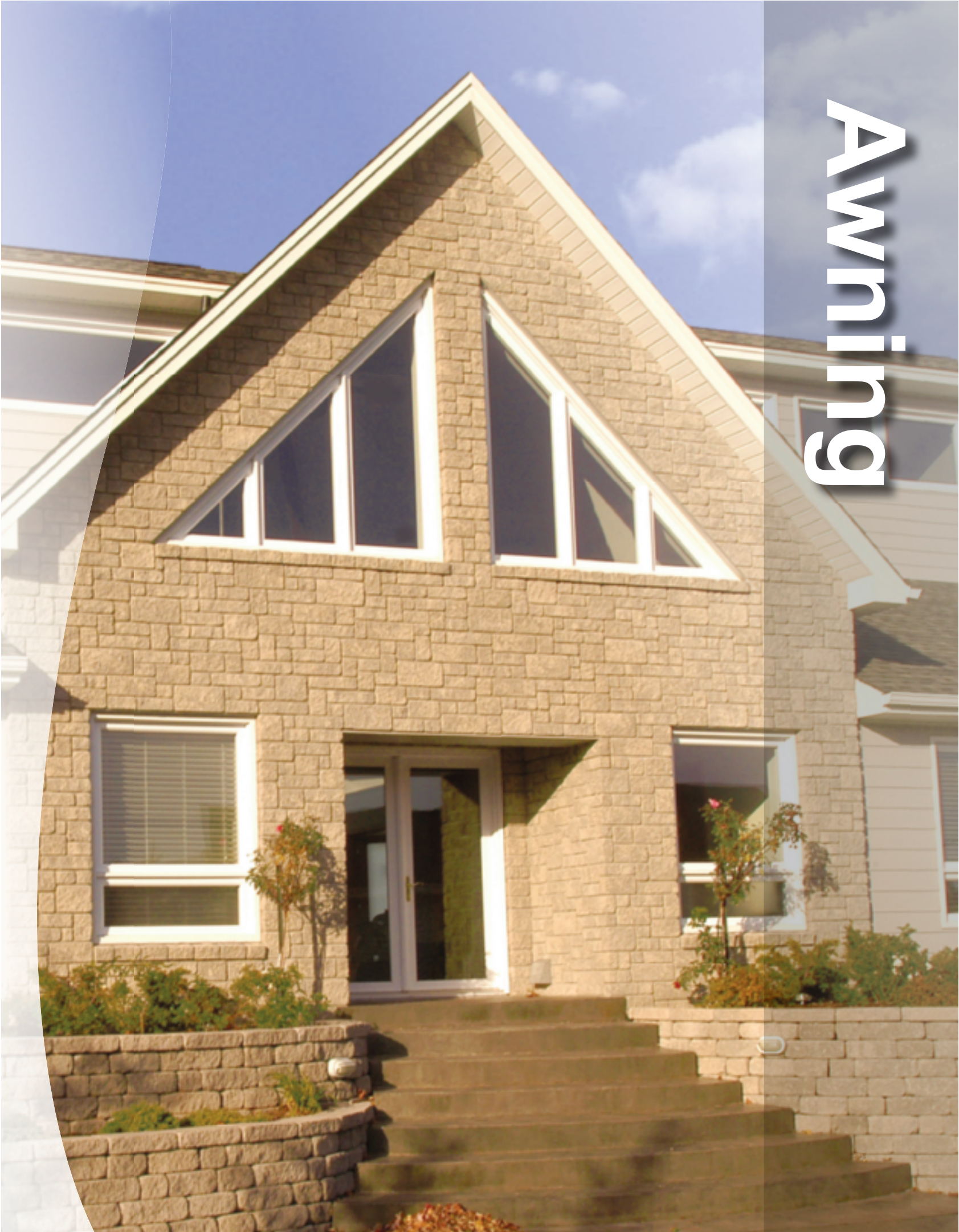

Awnning

Heritage Series



Double Hung 4000

- Both sashes open and tilt in for maximum ventilation and easy cleaning
- Efficient cam locking system for security and a weather-tight seal
- 3 1/4" PVC frame adds strength and durability
- Triple weatherstrip system
- Optional combination 1/2" drywall / 3/4" wood return
- See brickmold options available on page 24



Double Slider 4100

- Both sashes open and tilt in for maximum ventilation and easy cleaning
- Efficient cam locking system for security and a weather-tight seal
- 3 1/4" PVC frame adds strength and durability
- Triple weatherstrip system
- Optional combination 1/2" drywall / 3/4" wood return
- See brickmold options available on page 24



Single Slider 4300

- One sash is fixed for increased weather tightness
- Other sash opens and tilts in for easy cleaning
- Efficient cam locking system for security and a weather-tight seal
- 3 1/4" PVC frame adds strength and durability
- Optional combination 1/2" drywall / 3/4" wood return
- See brickmold options available on page 24

Premium Series



Single Slider 4356

- Available in 3 1/4" or 4 1/2" depths
- One sash is fixed for increased weather tightness
- Other sash opens and tilts in for easy cleaning
- Efficient cam locking system for security and a weather-tight seal
- Integrated 1 1/2" brickmold with nailing fin
- Integrated combination 1/2" drywall / 3/4" wood return
- Triple weatherstrip system

Double Hung & Slider



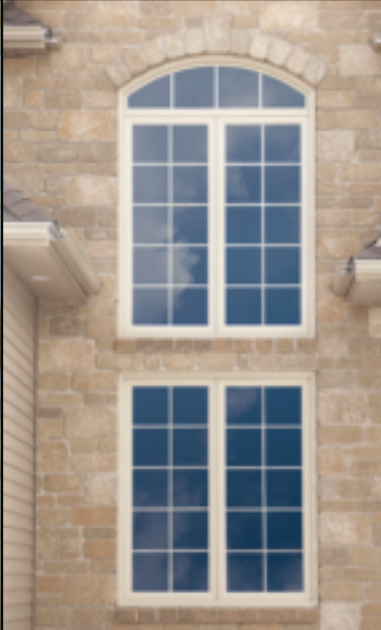

Designer Series

If you dream it, we will build it.

Extreme Window and Entrance Systems' range of custom options for your windows lets you bring your home to life. Virtually any shape, size, or combination is available as either free-standing window treatments or in a supporting role with our Heritage windows.

We all enjoy our homes differently. Therefore there is no better way to make your home shine with a thoughtful collaboration with our window experts to help make your dream come true.





Our Energy Saving Difference

Low-E Glass allows you to be warmer in the winter and cooler in the summer – saving on heating and air conditioning along the way. Low-E Glass is a series of virtually invisible layers of metallic coating inside the sealed unit that increases the insulating value of a double-glazed window. Low-E will also reduce the harmful effects of UV rays on your interior fabrics and finishes by up to 55%.

Argon Gas is a completely safe, naturally inert gas that can be pumped into the air space of the thermal pane. The lower thermal conduction and convection rates of Argon further increase the window insulating values. Include Argon Gas in combination with Low-E Glass for maximum benefit. Learn more about our energy ratings by visiting www.extremedoors.ca.

Good for your savings. Good for the planet.



CANCERTO
THE ECO
WINDOW™

Did you know?

The King penguins live in the southern hemisphere and spend up to 70% of their time at sea, resting on icebergs or drifting blocks of ice.

Experts estimate that if the temperature of our planet rises but just 2 degrees it could cause the extinction of 50% - 75% of the population of The King penguins.

Did you also know that by changing your windows to Extreme Energy Star qualified eco-windows, you can save up to 12% on your heating bill and contribute in reducing global warming.

Concerto windows made by Extreme Window & Entrance Systems are solid, elegant, and provide great savings for your heating bills.

Calculate your savings online. www.extremedoors.ca

Window Options...

maximum value with energy efficiency & options!

Window Series add-on components can suit any home.

- ① 1 1/2" J-brickmold
- ② 1 1/2" brickmold
- ③ 2 1/4" J-brickmold
- ④ 2 1/4" brickmold
- ⑤ 4" brickmold (can convert to J-type)
- ⑥ 6 3/4" jamb extension
- ⑦ 5 1/4" jamb extension
- ⑧ Rosette interior cornerblock
- ⑨ Colonial interior casing
- ⑩ Combination 1/2" drywall, 3/4" wood return



Trusted By...

developers and homeowners across Atlantic Canada!

Maximum value with a Lifetime Warranty that we guarantee for life.

At Extreme Window and Entrance Systems, we are committed to ensuring that your Windows and Entrance Systems keep your home looking beautiful for years to come. That's why we offer such a comprehensive warranty on all of our products.

- ✓ Vinyl Lifetime Warranty
- ✓ Insulated Glass Lifetime Warranty
- ✓ Window Hardware Lifetime Warranty
- ✓ *For more details, please refer to our to see our warranty card or visit www.extremedoors.ca.*



At Extreme Window and Entrances Systems we are always striving to improve our carbon footprint.

- *We recycle 100% of our PVC and Glass*
- *Use recycled paper for brochures*
- *We replaced all our toilets to low flow*
- *We even use spaghetti for coffee stir sticks!*



Fibreglass Entrances Systems

The beauty and texture of wood in long-lasting fibreglass.

Give your home incredible warmth and appeal with these amazing wood-textured fibreglass entrance systems. Paintable and stainable, these doors provide years of low-maintenance satisfaction. Notable features include:

- Deep wood-grain texture
- High-performance fibreglass facings
- Polyurethane core; engineered stiles
- Rot resistant bottom rail

Ask about our glass insert options.

We have a variety of glass insert options including silkscreen image, leaded lites with decorative glass, and even internal mini blinds.

Steel Entrance Systems

Extreme entrance systems come in a wide variety of styles and sizes and can be combined with Sidelites, Transoms, and other products to make beautiful feature installations. They may be very beautiful, but deep down they are doing very important jobs – protecting you and your family while saving your energy dollars. Constructed of the highest-quality galvanized steel, they offer superior durability and security as well as weather and rust resistance. Magnetic weatherstripping seals keep out wind, rain, and dust. Foamed-in-place polyurethane insulation ensures comfort and energy savings.

- High-quality CFC-11-free polyurethane core system that has been designed, engineered, and tested to provide superior insulation (R-16) and structural strength
- 1 1/4" stiles made of kiln-dried, finger-jointed wood to provide full length thermal barrier between interior and exterior
- Seamless vinyl cladding over finger joint pine prevents condensation (interior cladding available)
- Ball bearing hinges
- 24-gauge, G-60, hot-dipped galvanized steel for maximum rust protection
- 1" to 4" Brickmold available.
- Adjustable door sweep

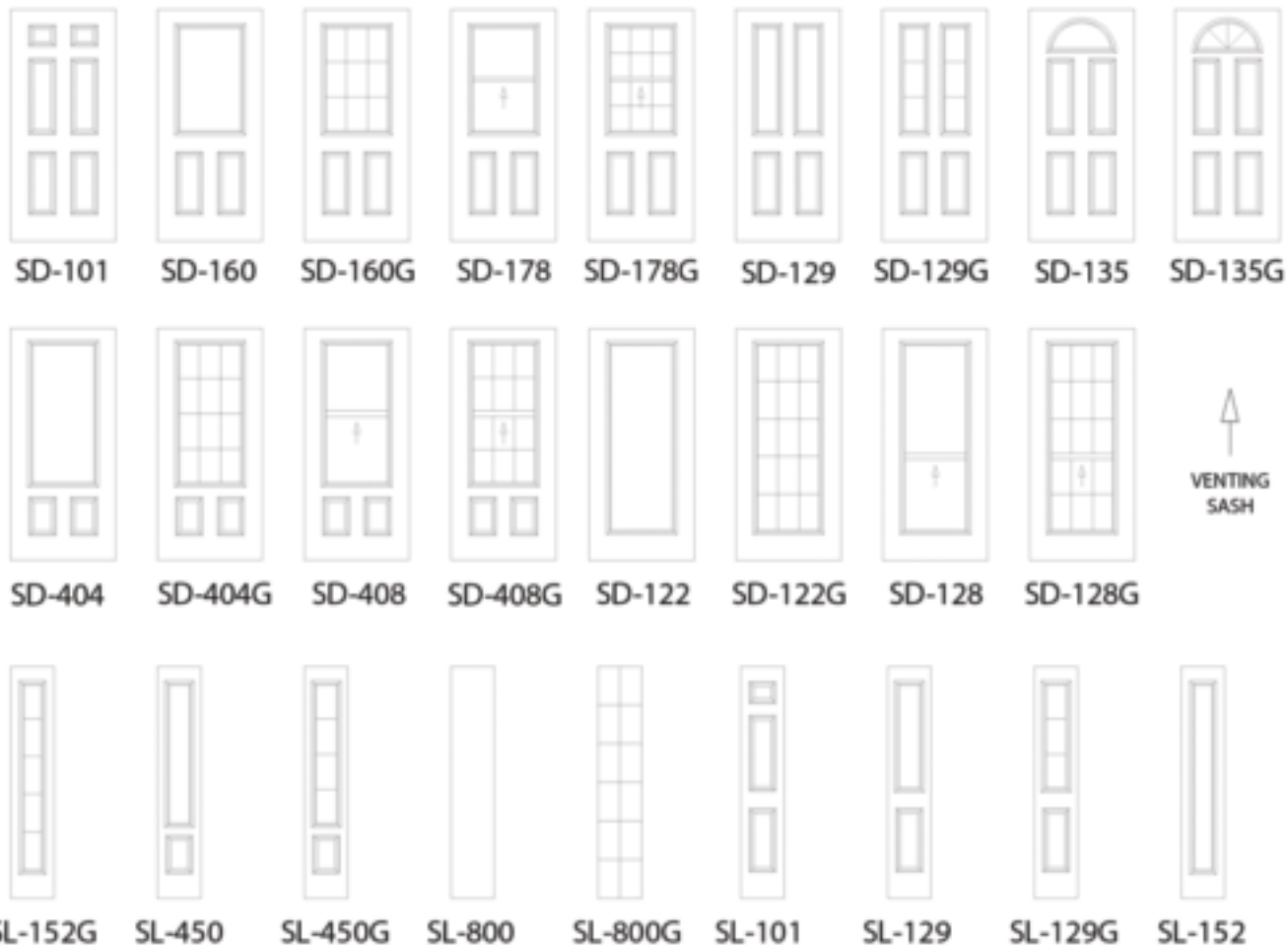

| Door Size | Single Door Dimensions | Door + 1 Sidelite | Door + 2 Sidelites |
|-----------|------------------------|-------------------|--------------------|
| 32" x 80" | 33 3/8" x 82 1/2" | 49 1/8" x 82 1/2" | 64 3/4" x 82 1/2" |
| 34" x 80" | 35 3/8" x 82 1/2" | 51 1/8" x 82 1/2" | 66 3/4" x 82 1/2" |
| 36" x 80" | 37 3/8" x 82 1/2" | 53 1/8" x 82 1/2" | 68 3/4" x 82 1/2" |

To calculate RSO, add 1" to the width and height.



Steel & Fiberglass Garden Doors

With all of the modern energy efficiencies and performance features built into them, our Garden Doors provide the perfect opportunity to connect your indoor and outdoor worlds with style. Whatever your choice, you can be sure it's the right one. Each door is made to meet or exceed rigorous Canadian performance standards and is backed by industry-leading performance warranty.

Bring the beauty of the outdoors into your home with these energy-efficient classics. The fixed panel adds strength to the centre post and hosts the sliding screen for days when you just want to let the outdoors in.

- High-quality construction
- Available with a range of grill, decorative glass, and mini-blind options
- Ball Bearing hinges
- Compression and magnetic weather-stripping
- Self-draining sill to ensure superior weather protection



Integra Patio Door

Designed for both energy efficiency and style, this gently sliding patio door combines the strength of a wood frame and mechanical sashes with the aesthetics and durability of PVC vinyl.

- ✓ Sturdy PVC sash and PVC-clad wood-frame
- ✓ Double and triple weather stripping for exceptional performance
- ✓ Double latch locking system with rounded D-shaped handle
- ✓ Double tandem adjustable nylon rollers with steel bearings
- ✓ Available in White or Tan
- ✓ Choose from standard 5 5/8" frame depths in standard 81 3/16" or optional 79 1/2" frame heights

OPTIONS

- ▶ Footlock and Keylock for added security
- ▶ Anti-Theft Security Bar (white only)
- ▶ Durable, High Quality Twin-Point Lock
- ▶ Wood /Vinyl Clad Brickmold and Aluminum Sill Extension
- ▶ Royalton Series handle available in 6 finishes.
- ▶ Screw-on nail fin for new construction application
- ▶ Glazing options - Low-E with Argon Gas and Warm Edge Spacer, Tinted, V-Groove, Grille, Internal Mini Blinds
- ▶ 5 7/8" wood frame (5 5/8" + 1/4" PVC extended clad)
- ▶ Optional interior extensions to achieve : 8 1/4", 8 1/2" and 9 1/4" overall depth
- ▶ Garden Panel

STANDARD SIZES

| Nominal Dimensions | 5 ft. | 6 ft. | 8 ft. | 7 1/2 ft. | 9 ft. | 12 ft. | 10 ft. | 12 ft. | 6'8" or 6'10" |
|---------------------------|---------|---------|---------|-----------|----------|----------|----------|----------|--------------------|
| Configurations | | | | | | | | | |
| Exterior-frame Dimensions | 59" | 71" | 95" | 87 3/4" | 105 3/4" | 141 3/4" | 115 3/4" | 139 3/4" | 79 1/2" or 81 1/8" |
| Minimum Rough Opening | 59 3/4" | 71 3/4" | 95 3/4" | 88 1/2" | 106 1/2" | 142 1/2" | 116 1/2" | 140 1/2" | 80" or 81 5/8" |
| | WIDTH | | | | | | | | HEIGHT |

X = Operating Sash O = Fixed Sash

- ✓ **WARRANTY** Integra patio door is delivered with a limited warranty: 20 years on PVC / 20 years on seal failure of glass / 1 year on operation.
Internal Mini-Blinds: 5 years on blind operation / 10 years on seal failure of glass

FEATURES

- ▶ 5 5/8" Vinyl and Wood frame for optimum strength 1
- ▶ Self-lubricating nylon tandem panel rollers provide smooth gliding action 2
- ▶ All exposed aluminum is anodized to prevent corrosion 3
- ▶ Plain stiles and interlocks are steel reinforced. Lock stiles are aluminum reinforced 4
- ▶ Sash panels are co-extruded with dual durometer flex PVC which surrounds the entire 1" thick I.G. unit for optimum seal and added strength and are field reversible 5
- ▶ Specially designed drainage system to prevent water from being trapped under I.G. unit 6
- ▶ Exclusive nylon screen roller system with an independent suspension at all four corners is designed with a side adjustment screw for easy leveling. Each individual wheel is precision-machined using a highly tensile strength plastic material called, Delrin® (Delrin is registered trademark of Dupont.)
- ▶ Heavy-duty extruded aluminum screen frame with nylon mesh, is designed for easy removal
- ▶ High performance sill design has a 10 degree slope for superior water tightness and drainage

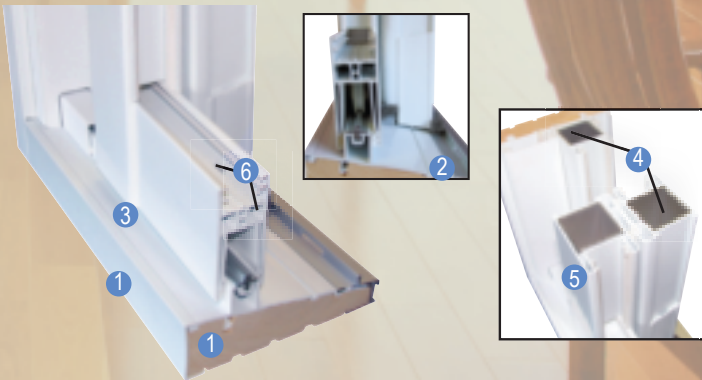

PERFORMANCE

CAN/CSA A440 ~ Size Tested: 71" x 81 1/8" OX/XO
 AAMA/WDMA/CSA 101.1.S.2/A440

| | Air Tightness | Water Resistance | Wind-load Resistance | Forced Entry | Ease of Operation | Energy Star |
|--------|---------------|------------------|----------------------|--------------|-------------------|--|
| Canada | A3 | B3 | C3 | F1 | E3 | Contact your sales representative for specific areas |



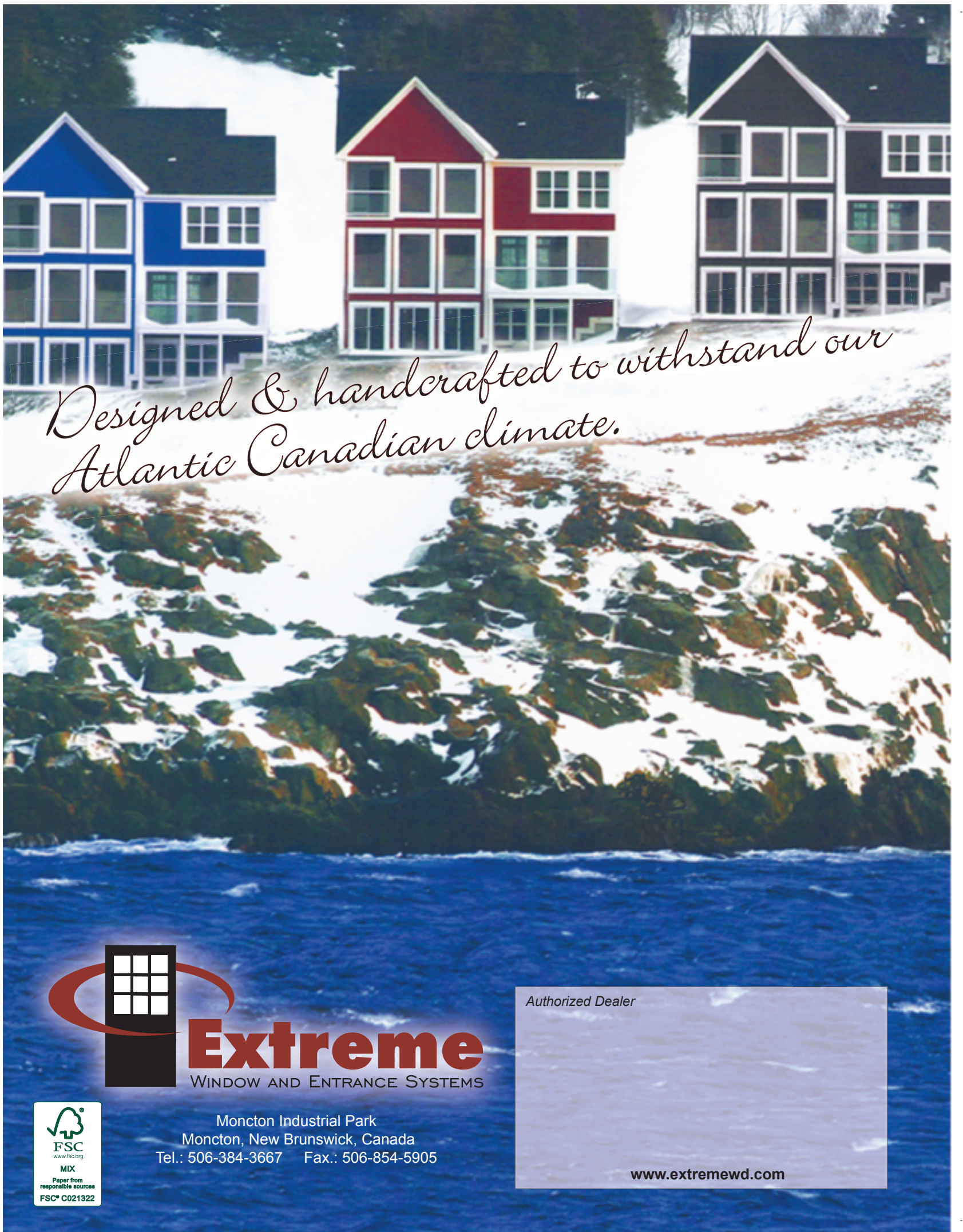

Designed & handcrafted to withstand our Atlantic Canadian climate.

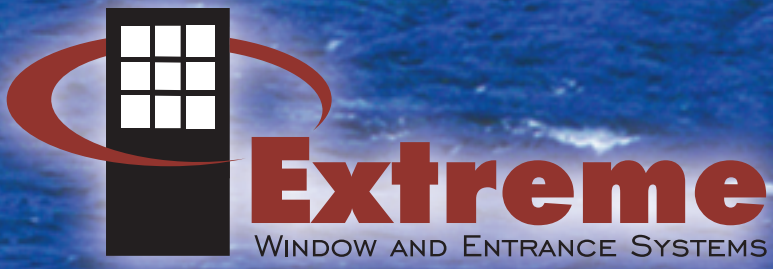

Moncton Industrial Park
Moncton, New Brunswick, Canada
Tel.: 506-384-3667 Fax.: 506-854-5905



www.extremewd.com